

Eared Pipes				
Description	65mm (2.5")	75mm (3")	100mm (4")	150mm (6")
1829mm (6') Eared	R2501E	R3001E	R4001E	R6001E
1219mm (4') Eared	R2504E	R3004E	R4004E	R6004E
914mm (3') Eared	R2503E	R3003E	R4003E	R6003E
610mm (2') Eared	R2502E	R3002E	R4002E	R6002E
1829mm (6') Double Socket Eared	R2501DE	R3001DE	R4001DE	R6001DE
Plain Pipes				
Description	65mm (2.5")	75mm (3")	100mm (4")	150mm (6")
1829mm (6') Plain	R2501	R3001	R4001	R6001
1219mm (4') Plain	R2504	R3004	R4004	R6004
914mm (3') Plain	R2503	R3003	R4003	R6003
610mm (2') Plain	R2502	R3002	R4002	R6002
1829mm (6') Double Socket Plain	R2501D	R3001D	R4001D	R6001D
Access Pipes				
Description	65mm (2.5")	75mm (3")	100mm (4")	150mm (6")
Oval Door Eared	R2510E	R3010E	R4010E	R6010E
Oval Door Plain	R2510	R3010	R4010	R6010
A	253mm	253mm	253mm	253mm
Bends				
Description	65mm (2.5")	75mm (3")	100mm (4")	150mm (6")
92.5°	R2520	R3020	R4020	R6020
A	140mm	140mm	159mm	208mm
B	140mm	137mm	159mm	186mm
112.5°	R2521	R3021	R4021	R6021
A	120mm	124mm	134mm	176mm
B	120mm	124mm	134mm	153mm
135°	R2522	R3022	R4022	R6022
A	108mm	125mm	136mm	154mm
B	108mm	100mm	103mm	130mm
Branches				
Description	65mm (2.5")	75mm (3")	100mm (4")	150mm (6")
92.5°	R2530	R3030	R4030	R6030
A	134mm	280mm	330mm	375mm
B	142mm	147mm	167mm	200mm
112.5°	R2531	R3031	R4031	R6031
A	120mm	130mm	140mm	385mm
B	143mm	164mm	180mm	223mm
135°	R2532	R3032	R4032	R6032
A	105mm	292mm	330mm	433mm
B	146mm	167mm	225mm	293mm
Loose Sockets				
Description	65mm (2.5")	75mm (3")	100mm (4")	150mm (6")
With Spigot Eared	R2550SE	R3050SE	R4050SE	R6050SE
With Spigot Plain	R2550S	R3050S	R4050S	R6050S
A	68mm	68mm	68mm	92mm
Diverter Kit				
Description	65mm (2.5")	75mm (3")	100mm (4")	
Diverter Kit	R2550DE	R3050DE	R4050DE	

Diverter Kit is available left handed as shown and also right handed.

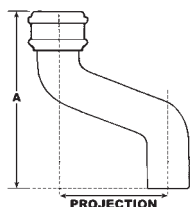

Offsets 112.5°				
Description	65mm (2.5")	75mm (3")	100mm (4")	150mm (6")
75mm (3") Projection	R2540	R3040	R4040	R6040
A	254mm	264mm	283mm	323mm
115mm (4.5") Projection	R2541	R3041	R4041	R6041
A	273mm	280mm	301mm	341mm
150mm (6") Projection	R2542	R3042	R4042	R6042
A	270mm	295mm	312mm	352mm
230mm (9") Projection	R2543	R3043	R4043	R6043
A	305mm	329mm	343mm	383mm
305mm (12") Projection	R2544	R3044	R4044	R6044
A	337mm	360mm	375mm	415mm
380mm (15") Projection	R2545	R3045	R4045	R6045
A	373mm	385mm	408mm	448mm
457mm (18") Projection	R2546	R3046	R4046	R6046
A	422mm	414mm	442mm	482mm
533mm (21") Projection	R2547	R3047	R4047	R6047
A	454mm	453mm	474mm	516mm
610mm (24") Projection	R2548	R3048	R4048	R6048
A	477mm	487mm	508mm	550mm

Shoes

Description	65mm (2.5")	75mm (3")	100mm (4")	150mm (6")
Eared	R2551E	R3051E	R4051E	R6051E
A	165mm	180mm	210mm	290mm
Plain	R2551	R3051	R4051	R6051
A	165mm	180mm	210mm	290mm
Anti-Splash Eared	R2552E	R3052E	R4052E	R6052E
A	219mm	222mm	265mm	325mm
Anti-Splash Plain	R2552	R3052	R4052	R6052
A	219mm	222mm	265mm	325mm

Ears

Description	65mm (2.5")	75mm (3")	100mm (4")	150mm (6")
Extra for Fitting Ears to Any Item	R2565F	R3065F	R4065F	R6065F

Holdfast

Description	65mm (2.5")	75mm (3")	100mm (4")	150mm (6")
Holdfast (Steel)	R2555	R3055	R4055	R6055

Pipe Bracket

Description	65mm (2.5")	75mm (3")	100mm (4")	150mm (6")
Screw to Wall (Zinc Plated)	R2561	R3061	R4061	R6061
A	45mm	45mm	45mm	45mm

Spacer Plate

Description	65mm (2.5")	75mm (3")	100mm (4")	150mm (6")
30mm Projection	R2570	R3070	R4070	R6070
A	113mm	133mm	160mm	215mm

Bobbins

Description	65mm (2.5")	75mm (3")	100mm (4")	150mm (6")
Wooden 30mm Projection			R0001	
Metal 13mm Projection			R0002	

Pipe Nails

Description	65mm (2.5")	75mm (3")	100mm (4")	150mm (6")
75mm (3") to suit All Pipe Sizes			R0003	
100mm (4") to suit All Pipe Sizes			R0004	

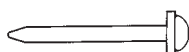
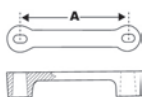
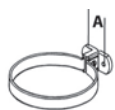
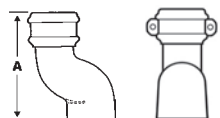
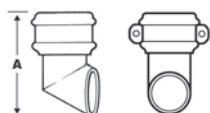

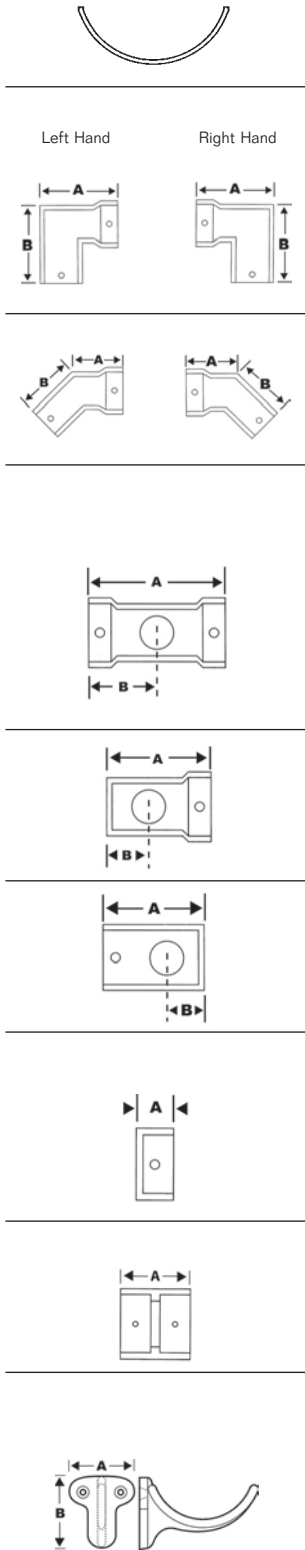

Plain Half Round Gutter				
Description	100mm (4")	115mm (4.5")	125mm (5")	150mm (6")
1829mm (6')	HR4001	HR4501	HR5001	HR6001
Angles				
Description	100mm (4")	115mm (4.5")	125mm (5")	150mm (6")
Square (90°) Left Hand	HR4010	HR4510	HR5010	HR6010
Square (90°) Right Hand	HR4011	HR4511	HR5011	HR6011
A	175mm	191mm	204mm	228mm
B	179mm	201mm	204mm	229mm
Obtuse (135°) Left Hand	HR4012	HR4512	HR5012	HR6012
Obtuse (135°) Right Hand	HR4013	HR4513	HR5013	HR6013
A	117mm	122mm	121mm	132mm
B	115mm	120mm	125mm	138mm
Outlets				
Description	100mm (4")	115mm (4.5")	125mm (5")	150mm (6")
A = 65mm (2.5"), B = 75mm (3"), C = 100mm (4")				
Nozzle (Centre Drop)	HR4020A	HR4520A	HR5020A	HR6020C
	HR4020B	HR4520B	HR5020B	HR6020B
A	240mm	240mm	240mm	240mm
B	120mm	120mm	120mm	120mm
Dropend External	HR4021A	HR4521A	HR5021A	HR6021C
	HR4021B	HR4521B	HR5021B	HR6021B
A	200mm	200mm	200mm	200mm
B	82mm	81mm	71mm	69mm
Dropend Internal	HR4022A	HR4522A	HR5022A	HR6022C
	HR4022B	HR4522B	HR5022B	HR6022B
A	200mm	200mm	200mm	200mm
B	60mm	60mm	60mm	60mm
Stopends				
Description	100mm (4")	115mm (4.5")	125mm (5")	150mm (6")
External	HR4030	HR4530	HR5030	HR6030
Internal	HR4031	HR4531	HR5031	HR6031
A	50mm	50mm	50mm	50mm
Union Clip				
Description	100mm (4")	115mm (4.5")	125mm (5")	150mm (6")
Union Clip	HR4035	HR4535	HR5035	HR6035
A	100mm	100mm	100mm	100mm
Fascia Bracket				
Description	100mm (4")	115mm (4.5")	125mm (5")	150mm (6")
Fascia Bracket	HR4040	HR4540	HR5040	HR6040
A	75mm	75mm	75mm	75mm
B	85mm	85mm	85mm	85mm

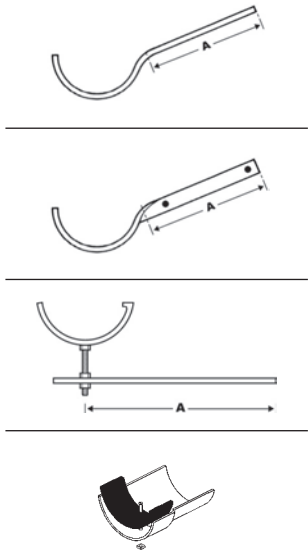

Galvanised Steel Brackets				
Description	100mm (4')	115mm (4.5')	125mm (5')	150mm (6')
Top Fixing Rafter Bracket	HR4041	HR4541	HR5041	HR6041
A	235mm	235mm	235mm	235mm
Side Fixing Rafter Bracket	HR4042	HR4542	HR5042	HR6042
A	190mm	190mm	190mm	190mm
Rise & Fall Bracket (Threaded Stem 130mm)	HR4043	HR4543	HR5043	HR6043
A	300mm	300mm	300mm	300mm
Gutter Joining Kit				
Description	NEW IMPROVED DESIGN			
10 Rubber Gaskets, Bolts, Nuts & Washers	HR0006			

Gutter Joining Kit is suitable for Plain Half Round and Beaded Half Round only.





Left Hand Right Hand

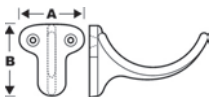
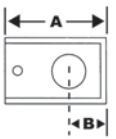
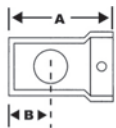
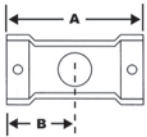
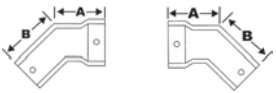
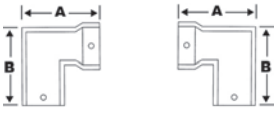

Beaded Half Round Gutter				
Description	100mm (4")	115mm (4.5")	125mm (5")	150mm (6")
1829mm (6')	HB4001	HB4501	HB5001	HB6001
Angles				
Description	100mm (4")	115mm (4.5")	125mm (5")	150mm (6")
Square (90°) Left Hand	HB4010	HB4510	HB5010	HB6010
Square (90°) Right Hand	HB4011	HB4511	HB5011	HB6011
A	180mm	199mm	210mm	228mm
B	182mm	200mm	212mm	228mm
Obtuse (135°) Left Hand	HB4012	HB4512	HB5012	HB6012
Obtuse (135°) Right Hand	HB4013	HB4513	HB5013	HB6013
A	117mm	126mm	130mm	134mm
B	115mm	126mm	130mm	134mm
Outlets				
Description	100mm (4")	115mm (4.5")	125mm (5")	150mm (6")
A = 65mm (2.5"), B = 75mm (3"), C = 100mm (4")				
Nozzle (Centre Drop)	HB4020A	HB4520A	HB5020A	HB6020C
	HB4020B	HB4520B	HB5020B	HB6020B
A	240mm	240mm	240mm	240mm
B	120mm	120mm	120mm	120mm
Dropend External	HB4021A	HB4521A	HB5021A	HB6021C
	HB4021B	HB4521B	HB5021B	HB6021B
A	195mm	195mm	195mm	195mm
B	81mm	80mm	59mm	75mm
Dropend Internal	HB4022A	HB4522A	HB5022A	HB6022C
	HB4022B	HB4522B	HB5022B	HB6022B
A	195mm	195mm	195mm	195mm
B	59mm	75mm	56mm	75mm
Stopends				
Description	100mm (4")	115mm (4.5")	125mm (5")	150mm (6")
External	HB4030	HB4530	HB5030	HB6030
Internal	HB4031	HB4531	HB5031	HB6031
A	50mm	50mm	50mm	50mm
Union Clip				
Description	100mm (4")	115mm (4.5")	125mm (5")	150mm (6")
Union Clip	HB4035	HB4535	HB5035	HB6035
A	100mm	100mm	100mm	100mm
Fascia Bracket				
Description	100mm (4")	115mm (4.5")	125mm (5")	150mm (6")
Fascia Bracket	HB4040	HB4540	HB5040	HB6040
A	75mm	75mm	75mm	75mm
B	85mm	85mm	85mm	85mm

Galvanised Steel Brackets

Description	100mm (4")	115mm (4.5")	125mm (5")	150mm (6")
Top Fixing Rafter Bracket	HB4041	HB4541	HB5041	HB6041
A	235mm	235mm	235mm	235mm
Side Fixing Rafter Bracket	HB4042	HB4542	HB5042	HB6042
A	190mm	190mm	190mm	190mm
Rise & Fall Bracket (Threaded Stem 130mm)	HB4043	HB4543	HB5043	HB6043
A	300mm	300mm	300mm	300mm

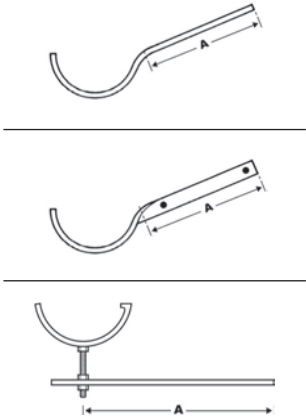

For Gutter Joining Kit please see page 17.



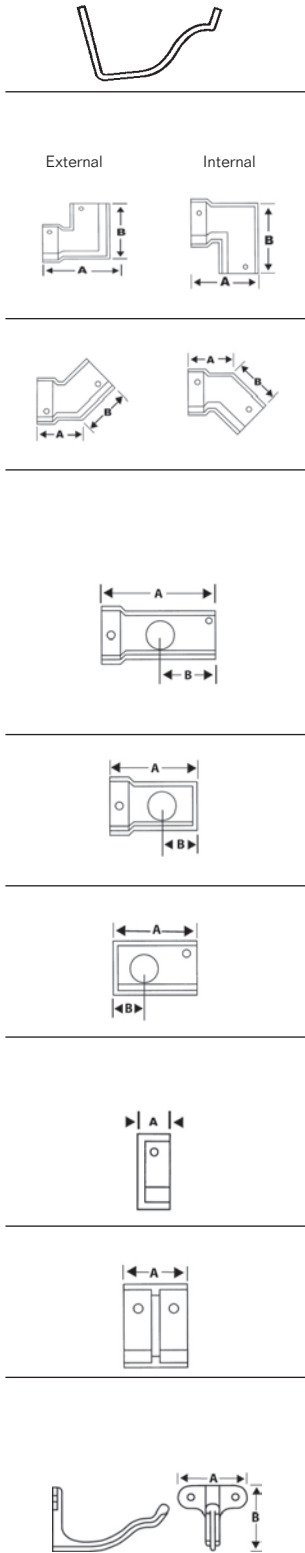

OG Gutter			
Description	100mm (4")	115mm (4.5")	125mm (5")
1829mm (6')	OG4001	OG4501	OG5001
Angles			
Description	100mm (4")	115mm (4.5")	125mm (5")
Square (90°) External	OG4010	OG4510	OG5010
Square (90°) Internal	OG4011	OG4511	OG5011
A	175mm	190mm	201mm
B	180mm	195mm	206mm
Obtuse (135°) External	OG4012	OG4512	OG5012
Obtuse (135°) Internal	OG4013	OG4513	OG5013
A	112mm	114mm	125mm
B	115mm	121mm	130mm
Outlets			
Description	100mm (4")	115mm (4.5")	125mm (5")
A= 65mm (2.5"), B= 75mm (3")			
Nozzle (Centre Drop)	OG4020A	OG4520A	OG5020A
	OG4020B	OG4520B	OG5020B
A	240mm	240mm	240mm
B	120mm	120mm	120mm
Dropend External	OG4021A	OG4521A	OG5021A
	OG4021B	OG4521B	OG5021B
A	170mm	170mm	170mm
B	63mm	63mm	65mm
Dropend Internal	OG4022A	OG4522A	OG5022A
	OG4022B	OG4522B	OG5022B
A	170mm	170mm	170mm
B	60mm	60mm	65mm
Stopends			
Description	100mm (4")	115mm (4.5")	125mm (5")
External (Right Hand)	OG4030	OG45430	OG5030
Internal (Left Hand)	OG4031	OG4531	OG5031
A	45mm	45mm	45mm
Union Clip			
Description	100mm (4")	115mm (4.5")	125mm (5")
Union Clip	OG4035	OG4535	OG5035
A	100mm	100mm	100mm
Fascia Bracket			
Description	100mm (4")	115mm (4.5")	125mm (5")
Fascia Bracket	OG4040	OG4540	OG5040
A	75mm	75mm	75mm
B	70mm	77mm	83mm

Galvanised Steel Brackets

Description	100mm (4")	115mm (4.5")	125mm (5")
Top Fixing Rafter Bracket	OG4041	OG4541	OG5041
A	300mm	240mm	300mm
Side Fixing Rafter Bracket	OG4042	OG4542	OG5042
A	300mm	240mm	300mm
Rise & Fall Bracket (Threaded Stem 160mm)	OG4043	OG4543	OG5043
A	300mm	240mm	300mm

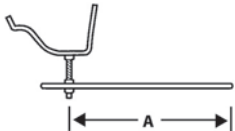



External



Internal

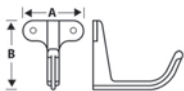
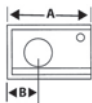
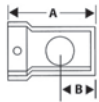
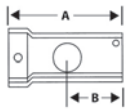
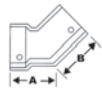

Notts OG Gutter

Description	115mm (4.5")
1829mm (6')	NO4501

Angles

Description	115mm (4.5")
Square (90°) External	NO4510
Square (90°) Internal	NO4511
A	244mm
B	235mm
Obtuse (135°) External	NO4512
Obtuse (135°) Internal	NO4513
A	120mm
B	121mm

Outlets

Description	115mm (4.5")
	A= 65mm (2.5"), B= 75mm (3")
Nozzle (Centre Drop)	NO4520A
	NO4520B
A	266mm
B	132mm
Dropend External	NO4521A
	NO4521B
A	175mm
B	65mm
Dropend Internal	NO4522A
	NO4522B
A	175mm
B	57mm

Stopends

Description	115mm (4.5")
External	NO4530
Internal	NO4531
A	45mm

Union Clip

Description	115mm (4.5")
Union Clip	NO4535
A	100mm

Fascia Bracket

Description	115mm (4.5")
Fascia Bracket	NO4540
A	75mm
B	85mm

Galvanised Steel Brackets

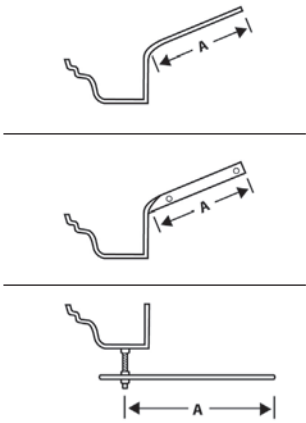

Galvanised Steel Brackets	
Description	115mm (4.5")
Top Fixing Rafter Bracket	NO4541
A	300mm
Side Fixing Rafter Bracket	NO4542
A	240mm
Rise & Fall Bracket (Threaded Stem 160mm)	NO4543
A	300mm





External

Internal

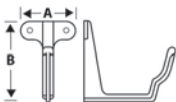
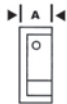
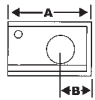
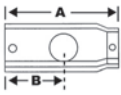

G46 Moulded Gutter		
Description	100mm x 75mm (4" x 3")	125mm x 100mm (5" x 4")
1829mm (6')	G4301	G5401
Angles		
Description	100mm x 75mm (4" x 3")	125mm x 100mm (5" x 4")
Square (90°) External	G4310	G5410
Square (90°) Internal	G4311	G5411
A	178mm	208mm
B	180mm	205mm
Obtuse (135°) External	G4312	G5412
Obtuse (135°) Internal	G4313	G5413
A	109mm	130mm
B	115mm	128mm
Outlets		
Description	100mm x 75mm (4" x 3")	125mm x 100mm (5" x 4")
Nozzle (Centre Drop)	A = 65mm (2.5"), B = 5mm (3") (100mm (4") & 100mm x 75mm (4" x 3") outlets are also available)	
	G4320A	G5420A
	G4320B	G5420B
A	250mm	252mm
B	126mm	126mm
Dropend External	G4321A	G5421A
	G4321B	G5421B
A	170mm	172mm
B	65mm	65mm
Dropend Internal	G4322A	G5422A
	G4322B	G5422B
A	178mm	181mm
B	65mm	65mm
Stopends		
Description	100mm x 75mm (4" x 3")	125mm x 100mm (5" x 4")
External	G4330	G5430
A	60mm	60mm
Internal	G4331	G5431
A	45mm	58mm
Union Clip		
Description	100mm x 75mm (4" x 3")	125mm x 100mm (5" x 4")
Union Clip	G4335	G5435
A	100mm	100mm
Fascia Bracket		
Description	100mm x 75mm (4" x 3")	125mm x 100mm (5" x 4")
Fascia Bracket	G4340	G5440
A	75mm	75mm
B	85mm	110mm

Galvanised Steel Brackets

Description	100mm x 75mm (4" x 3")	125mm x 100mm (5" x 4")
Top Fixing Rafter Bracket	G4341	G5441
A	300mm	300mm
Side Fixing Rafter Bracket	G4342	G5442
A	240mm	240mm
Rise & Fall Bracket (Threaded Stem 160mm)	G4343	G5443
A	300mm	300mm

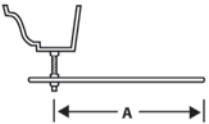
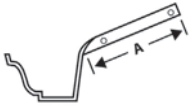
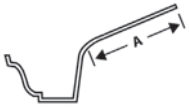



Left Hand Right Hand

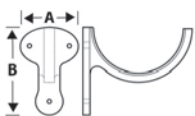
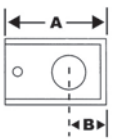
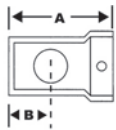
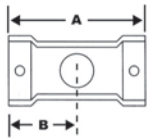
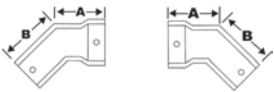
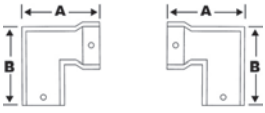

Plain Deep Half Round Gutter		
Description	100mm x 75mm (4" x 3")	125mm x 75mm (5" x 3")
1829mm (6')	DH4301	DH5301
Angles		
Description	100mm x 75mm (4" x 3")	125mm x 75mm (5" x 3")
Square (90°) Left Hand	DH4310	DH5310
Square (90°) Right Hand	DH4311	DH5311
A	280mm	297mm
B	285mm	295mm
Obtuse (135°) Left Hand	DH4312	DH5312
Obtuse (135°) Right Hand	DH4313	DH5313
A	185mm	184mm
B	185mm	184mm
Outlets		
Description	100mm x 75mm (4" x 3")	125mm x 75mm (5" x 3")
A = 65mm (2.5"), B = 75mm (3")		
Nozzle (Centre Drop)	DH4320A	DH5320A
	DH4320B	DH5320B
A	240mm	240mm
B	120mm	120mm
Dropend External	DH4321A	DH5321A
	DH4321B	DH5321B
A	175mm	200mm
B	60mm	60mm
Dropend Internal	DH4322A	DH5322A
	DH4322B	DH5322B
A	170mm	200mm
B	60mm	60mm
Stopends		
Description	100mm x 75mm (4" x 3")	125mm x 75mm (5" x 3")
External	DH4330	DH5330
Internal	DH4331	DH5331
A	45mm	50mm
Union Clip		
Description	100mm x 75mm (4" x 3")	125mm x 75mm (5" x 3")
Union Clip	DH4335	DH5335
A	100mm	100mm
Fascia Bracket		
Description	100mm x 75mm (4" x 3")	125mm x 75mm (5" x 3")
Fascia Bracket	DH4340	DH5340
A	89mm	87mm
B	131mm	117mm

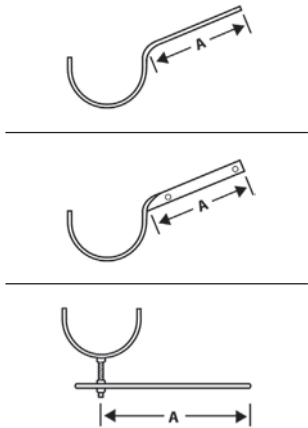

Galvanised Steel Brackets		
Description	100mm x 75mm (4" x 3")	125mm x 75mm (5" x 3")
Top Fixing Rafter Bracket	DH4341	DH5341
A	235mm	235mm
Side Fixing Rafter Bracket	DH4342	DH5342
A	190mm	190mm
Rise & Fall Bracket (Threaded Stem 130mm)	DH4343	DH5343
A	300mm	300mm



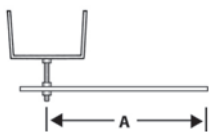
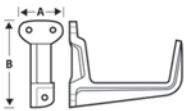
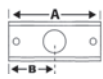
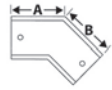
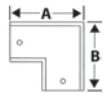
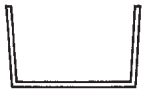

Double Spigot Box Gutter	
Description	100mm x 75mm (4" x 3")
1829mm (6')	B4301
Angles	
Description	100mm x 75mm (4" x 3")
Square (90°)	B4310
A	195mm
B	195mm
Obtuse (135°)	B4311
A	142mm
B	142mm
Outlets	
Description	100mm x 75mm (4" x 3")
A= 65mm (2.5"), B= 75mm (3")	
Nozzle (Centre Drop)	B4320A
	B4320B
A	236mm
B	115mm
Stopends	
Description	100mm x 75mm (4" x 3")
Internal Stopend	B4330
A	54mm
Union Clip	
Description	100mm x 75mm (4" x 3")
Union Clip	B4335
A	108mm
Fascia Bracket	
Description	100mm x 75mm (4" x 3")
Fascia Bracket	B4340
A	51mm
B	100mm
Galvanised Steel Brackets	
Description	100mm x 75mm (4" x 3")
Top Fixing Rafter Bracket	B4341
A	300mm
Side Fixing Rafter Bracket	B4342
A	240mm
Rise & Fall Bracket (Threaded Stem 130mm)	B4343
A	300mm

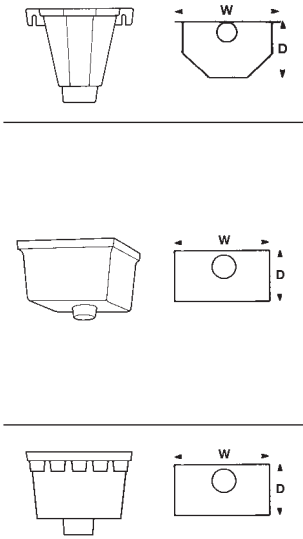

Standard Heads		
Description	Width x Depth x Height	
H0 Flat Back 65mm (2.5")	210mm x 163mm x 195mm	RH025
H0 Flat Back 75mm (3")	210mm x 163mm x 195mm	RH03
H0 Flat Back 100mm (4")	253mm x 210mm x 210mm	RH04
H460 Rectangular Plain 65mm (2.5")	255mm x 178mm x 178mm	RH46010
H460 Rectangular Plain 75mm (3")	255mm x 178mm x 178mm	RH460103
H460 Rectangular Plain 100mm (4")	255mm x 178mm x 178mm	RH460104
H460 Rectangular Plain 100mm x 75mm (4" x 3")	255mm x 178mm x 178mm	RH4601043
H460 Rectangular Plain 65mm (2.5")	305mm x 250mm x 200mm	RH46012
H460 Rectangular Plain 75mm (3")	305mm x 250mm x 200mm	RH460123
H460 Rectangular Plain 100mm (4")	305mm x 250mm x 200mm	RH460124
H460 Rectangular Plain 100mm x 75mm (4" x 3")	305mm x 250mm x 200mm	RH4601243
H460D Rectangular Castellated 65mm (2.5")	255mm x 178mm x 178mm	RH46010D
H460D Rectangular Castellated 75mm (3")	255mm x 178mm x 178mm	RH460103D

sundries

Gutter Bolt, Nut & Washer	
Description	
M6 x 25mm Bolt, Nut & Washer (Zinc Plated)	HR0001
Silicone Sealant	
Description	
300ml Cartridge of Sealquick Sealant	HR0002
Gutter Fixing Screw	
Description	
16g x 30mm Mushroom Head Screw (Zinc Plated)	HR0003
Bracket Screw	
Description	
No. 10 x 32mm Round Head Pozzi Screw (Zinc Plated)	HR0004
Touch Up Paint	
Description	
250ml Black Semi-Gloss Finish	XP0007

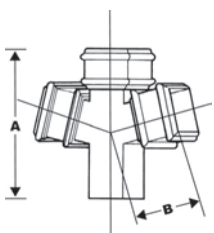
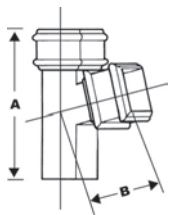
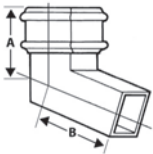
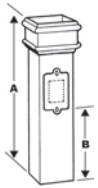
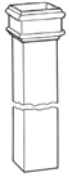
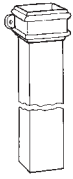

Eared Pipes			
Description	75mm x 75mm (3" x 3")	100mm x 100mm (4" x 4")	125mm x 125mm (5" x 5")
1829mm (6') Eared	SQ3301E	SQ4401E	SQ5501E
1210mm (4') Eared	SQ3304E	SQ4404E	SQ5504E
914mm (3') Eared	SQ3303E	SQ4403E	SQ5503E
610mm (2') Eared	SQ3302E	SQ4402E	SQ5502E
Plain Pipes			
Description	75mm x 75mm (3" x 3")	100mm x 100mm (4" x 4")	125mm x 125mm (5" x 5")
1829mm (6') Plain	SQ3301	SQ4401	SQ5501
1210mm (4') Plain	SQ3304	SQ4404	SQ5504
914mm (3') Plain	SQ3303	SQ4403	SQ5503
610mm (2') Plain	SQ3302	SQ4402	SQ5502
Access Pipes			
Description	75mm x 75mm (3" x 3")	100mm x 100mm (4" x 4")	125mm x 125mm (5" x 5")
Eared	SQ3310E	SQ4410E	SQ5510E
Plain	SQ3310	SQ4410	SQ5510
A	610mm	610mm	610mm
B	230mm	230mm	230mm
Bends			
Description	75mm x 75mm (3" x 3")	100mm x 100mm (4" x 4")	125mm x 125mm (5" x 5")
92.5 °	SQ3320	SQ4420	SQ5520
A	138mm	150mm	164mm
B	168mm	180mm	192mm
112.5 °	SQ3321	SQ4421	SQ5521
A	128mm	144mm	158mm
B	178mm	198mm	213mm
135 °	SQ3322	SQ4422	SQ5522
A	122mm	129mm	128mm
B	190mm	208mm	230mm
Branches			
Description	75mm x 75mm (3" x 3")	100mm x 100mm (4" x 4")	125mm x 125mm (5" x 5")
Single 92.5°	SQ3330	SQ4430	SQ5530
A	296mm	309mm	322mm
B	145mm	158mm	170mm
Single 112.5°	SQ3331	SQ4431	SQ5531
A	311mm	330mm	349mm
B	162mm	181mm	200mm
Single 135°	SQ3332	SQ4432	SQ5532
A	368mm	386mm	416mm
B	206mm	236mm	266mm
Double 92.5°	SQ3333	SQ4433	SQ5533
A	296mm	309mm	322mm
B	145mm	158mm	170mm
Double 112.5°	SQ3334	SQ4434	SQ5534
A	311mm	330mm	349mm
B	162mm	181mm	200mm
Double 135°	SQ3335	SQ4435	SQ5535
A	368mm	386mm	416mm
B	206mm	236mm	266mm

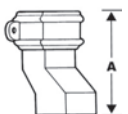
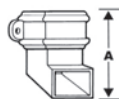
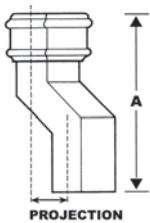
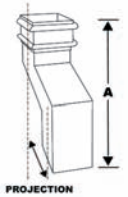
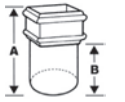
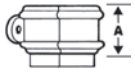

Loose Sockets			
Description	75mm x 75mm (3" x 3")	100mm x 100mm (4" x 4")	125mm x 125mm (5" x 5")
Eared	SQ3350E	SQ4450E	SQ5550E
Plain	SQ3350	SQ4450	SQ5550
A	92mm	92mm	92mm
Connector			
Description	75mm x 75mm (3" x 3")	100mm x 100mm (4" x 4")	125mm x 125mm (5" x 5")
Square to Round	SQ3325	SQ4425	SQ5525
A	243mm	245mm	245mm
B	150mm	150mm	150mm
Plinth Offsets 135°			
Description	75mm x 75mm (3" x 3")	100mm x 100mm (4" x 4")	125mm x 125mm (5" x 5")
115mm (4.5") Projection Eared	SQ3342PE	SQ4442PE	SQ5542PE
115mm (4.5") Projection Plain	SQ3342P	SQ4442P	SQ5542P
A	340mm	360mm	380mm
Offsets 112.5°			
Description	75mm x 75mm (3" x 3")	100mm x 100mm (4" x 4")	125mm x 125mm (5" x 5")
56mm (2.25") Projection	SQ3340	SQ4440	SQ5540
A	248mm	269mm	290mm
75mm (3") Projection	SQ3341	SQ4441	SQ5541
A	255mm	277mm	297mm
115mm (4.5") Projection	SQ3342	SQ4442	SQ5542
A	272mm	294mm	313mm
150mm (6") Projection	SQ3343	SQ4443	SQ5543
A	287mm	310mm	329mm
230mm (9") Projection	SQ3344	SQ4444	SQ5544
A	319mm	340mm	361mm
305mm (12") Projection	SQ3345	SQ4445	SQ5545
A	360mm	372mm	392mm
380mm (15") Projection	SQ3346	SQ4446	SQ5546
A	382mm	404mm	484mm
457mm (18") Projection	SQ3347	SQ4447	SQ5547
A	414mm	434mm	455mm
533mm (21") Projection	SQ3348	SQ4448	SQ5548
A	445mm	466mm	487mm
610mm (24") Projection	SQ3349	SQ4449	SQ5549
A	477mm	498mm	519mm
Shoes			
Description	75mm x 75mm (3" x 3")	100mm x 100mm (4" x 4")	125mm x 125mm (5" x 5")
Eared	SQ3351E	SQ4451E	SQ5551E
Plain	SQ3351	SQ4451	SQ5551
A	192mm	225mm	264mm
Anti-Splash Eared	SQ3352E	SQ4452E	SQ5552E
Anti-Splash Plain	SQ3352	SQ4452	SQ5552
A	250mm	273mm	302mm

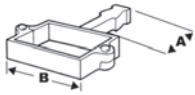

Holderbat			
Description	75mm x 75mm (3" x 3")	100mm x 100mm (4" x 4")	125mm x 125mm (5" x 5")
Build-in (to fit Socket)	SQ3360	SQ4460	SQ5560
A	116mm	116mm	116mm
B	115mm	141mm	166mm
Ears			
Description	75mm x 75mm (3" x 3")	100mm x 100mm (4" x 4")	125mm x 125mm (5" x 5")
Extra for Fitting Ears to Any Item	SQ3365F	SQ4465F	SQ5565F
Earbands			
Description	75mm x 75mm (3" x 3")	100mm x 100mm (4" x 4")	125mm x 125mm (5" x 5")
Plain	SQ3365	SQ4465	SQ5565
Ornamental Please See Below for Available Styles	SQ3365O	SQ4465O	SQ5565O

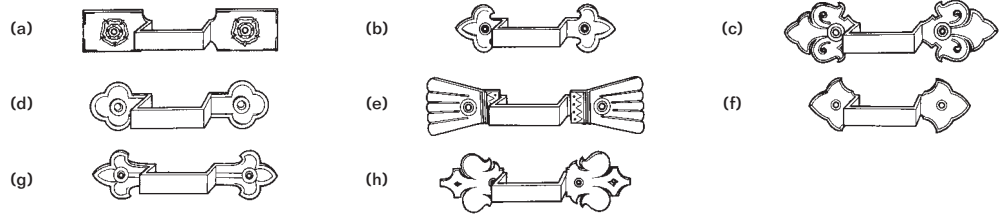

Other styles available to special order.

Please note earbands are manufactured to fit pipe socket.
Any additional information regarding specific sizes can be supplied upon request.



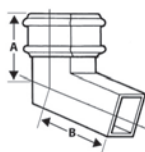
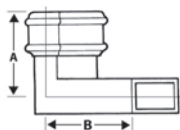
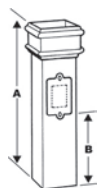
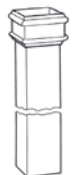
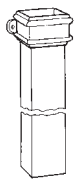

Eared Pipes				
Description	100mm x 75mm (4" x 3")	125mm x 70mm (5" x 2.75")	125mm x 100mm (5" x 4")	150mm x 100mm (6" x 4")
1829mm (6') Eared	RT4301E	RT5301E	RT5401E	RT6401E
1210mm (4') Eared	RT4304E	RT5304E	RT5404E	RT6404E
914mm (3') Eared	RT4303E	RT5303E	RT5403E	RT6403E
610mm (2') Eared	RT4302E	RT5302E	RT5402E	RT6402E
Plain Pipes				
Description	100mm x 75mm (4" x 3")	125mm x 70mm (5" x 2.75")	125mm x 100mm (5" x 4")	150mm x 100mm (6" x 4")
1829mm (6') Plain	RT4301	RT5301	RT5401	RT6401
1210mm (4') Plain	RT4304	RT5304	RT5404	RT6404
914mm (3') Plain	RT4303	RT5303	RT5403	RT6403
610mm (2') Plain	RT4302	RT5302	RT5402	RT6402
Access Pipes				
Description	100mm x 75mm (4" x 3")	125mm x 70mm (5" x 2.75")	125mm x 100mm (5" x 4")	150mm x 100mm (6" x 4")
Eared	RT4310E	RT5310E	RT5410E	RT6410E
Plain	RT4310	RT5310	RT5410	RT6410
A	610mm	610mm	610mm	610mm
B	230mm	230mm	230mm	230mm
Bends				
Description	100mm x 75mm (4" x 3")	125mm x 70mm (5" x 2.75")	125mm x 100mm (5" x 4")	150mm x 100mm (6" x 4")
Front 92.5°	RT4320	RT5320	RT5420	RT6420
A	138mm	138mm	150mm	164mm
B	168mm	168mm	180mm	192mm
Front 112.5°	RT4321	RT5321	RT5421	RT6421
A	128mm	128mm	144mm	158mm
B	178mm	178mm	198mm	213mm
Front 135°	RT4322	RT5322	RT5422	RT6422
A	122mm	122mm	129mm	128mm
B	190mm	190mm	208mm	230mm
Side 92.5°	RS4320	RS5320	RS5420	RS6420
A	145mm	147mm	147mm	159mm
B	145mm	162mm	162mm	174mm
Side 112.5°	RS4321	RS5321	RS5421	RS6421
A	134mm	143mm	143mm	152mm
B	134mm	143mm	143mm	152mm
Side 135°	RS4322	RS5322	RS5422	RS6422
A	125mm	131mm	131mm	137mm
B	125mm	131mm	131mm	137mm

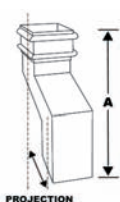
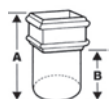
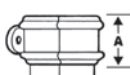
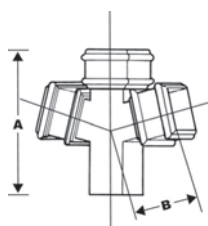
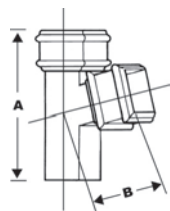

Branches				
Description	100mm x 75mm (4" x 3")	125mm x 70mm (5" x 2.75")	125mm x 100mm (5" x 4")	150mm x 100mm (6" x 4")
Single 92.5°	RT4330	RT5330	RT5430	RT6430
A	308mm	321mm	321mm	355mm
B	158mm	171mm	171mm	184mm
Single 112.5°	RT4331	RT5331	RT5431	RT6431
A	330mm	350mm	350mm	389mm
B	181mm	200mm	200mm	218mm
Single 135°	RT4332	RT5332	RT5432	RT6432
A	387mm	418mm	418mm	469mm
B	237mm	268mm	268mm	298mm
Double 92.5°	RT4333	RT5333	RT5433	RT6433
A	308mm	321mm	321mm	335mm
B	158mm	171mm	171mm	184mm
Double 112.5°	RT4334	RT5334	RT5434	RT6434
A	330mm	350mm	350mm	389mm
B	181mm	200mm	200mm	218mm
Double 135°	RT4335	RT5335	RT5435	RT6435
A	387mm	418mm	418mm	469mm
B	237mm	268mm	268mm	298mm
Loose Sockets				
Description	100mm x 75mm (4" x 3")	125mm x 70mm (5" x 2.75")	125mm x 100mm (5" x 4")	150mm x 100mm (6" x 4")
Eared	RT4350E	RT5350E	RT5450E	RT6450E
Plain	RT4350	RT5350	RT5450	RT6450
A	92mm	92mm	92mm	92mm
Connector				
Description	100mm x 75mm (4" x 3")	125mm x 70mm (5" x 2.75")	125mm x 100mm (5" x 4")	150mm x 100mm (6" x 4")
Rectangular to Round	RT4325	RT5325	RT5425	RT6425
A	245mm	250mm	250mm	250mm
B	150mm	150mm	150mm	150mm
Plinth Offsets 135°				
Description	100mm x 75mm (4" x 3")	125mm x 70mm (5" x 2.75")	125mm x 100mm (5" x 4")	150mm x 100mm (6" x 4")
115mm (4.5") Projection Eared	RT4342PE	RT5342PE	RT5442PE	RT6442PE
115mm (4.5") Projection Plain	RT4342P	RT5342P	RT5442P	RT6442P
A	340mm	343mm	360mm	360mm

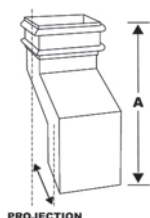

Front Offsets 112.5°				
Description	100mm x 75mm (4" x 3")	125mm x 70mm (5" x 2.75")	125mm x 100mm (5" x 4")	150mm x 100mm (6" x 4")
56mm (2.25") Projection	RT4340	RT5340	RT5440	RT6440
A	248mm	251mm	269mm	269mm
75mm (3") Projection	RT4341	RT5341	RT5441	RT6441
A	255mm	258mm	277mm	277mm
115mm (4.5") Projection	RT4342	RT5342	RT5442	RT6442
A	272mm	275mm	294mm	294mm
150mm (6") Projection	RT4343	RT5343	RT5443	RT6443
A	287mm	290mm	310mm	310mm
230mm (9") Projection	RT4344	RT5344	RT5444	RT6444
A	319mm	322mm	340mm	340mm
305mm (12") Projection	RT4345	RT5345	RT5445	RT6445
A	350mm	353mm	372mm	372mm
380mm (15") Projection	RT4346	RT5346	RT5446	RT6446
A	382mm	385mm	404mm	404mm
457mm (18") Projection	RT4347	RT5347	RT5447	RT6447
A	414mm	417mm	434mm	434mm
533mm (21") Projection	RT4348	RT5348	RT5448	RT6448
A	445mm	448mm	466mm	466mm
610mm (24") Projection	RT4349	RT5349	RT5449	RT6449
A	477mm	480mm	498mm	498mm

Side Offsets 112.5°				
Description	100mm x 75mm (4" x 3")	125mm x 70mm (5" x 2.75")	125mm x 100mm (5" x 4")	150mm x 100mm (6" x 4")
56mm (2.25") Projection	RS4340	RS5340	RS5440	RS6440
A	269mm	290mm	290mm	306mm
75mm (3") Projection	RS4341	RS5341	RS5441	RS6441
A	277mm	297mm	297mm	313mm
115mm (4.5") Projection	RS4342	RS5342	RS5442	RS6442
A	294mm	313mm	313mm	329mm
150mm (6") Projection	RS4343	RS5343	RS5443	RS6443
A	310mm	329mm	329mm	345mm
230mm (9") Projection	RS4344	RS5344	RS5444	RS6444
A	340mm	361mm	361mm	376mm
305mm (12") Projection	RS4345	RS5345	RS5445	RS6445
A	345mm	392mm	392mm	408mm
380mm (15") Projection	RS4346	RS5346	RS5446	RS6446
A	404mm	424mm	424mm	440mm
457mm (18") Projection	RS4347	RS5347	RS5447	RS6447
A	434mm	455mm	455mm	471mm
533mm (21") Projection	RS4348	RS5348	RS5448	RS6448
A	466mm	487mm	487mm	503mm
610mm (24") Projection	RS4349	RS5349	RS5449	RS6449
A	498mm	519mm	519mm	535mm

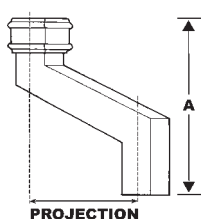

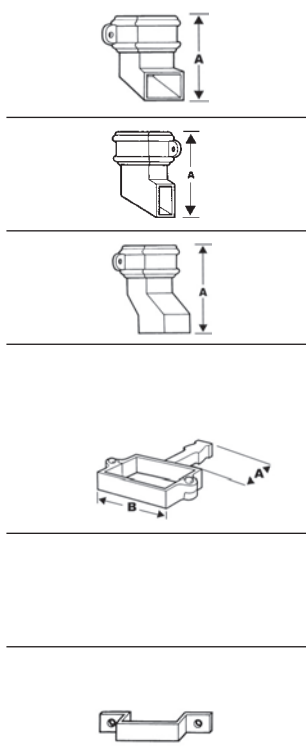

Shoes				
Description	100mm x 75mm (4" x 3")	125mm x 70mm (5" x 2.75")	125mm x 100mm (5" x 4")	150mm x 100mm (6" x 4")
Front Eared	RT4351E	RT5351E	RT5451E	RT6451E
Front Plain	RT4351	RT5351	RT5451	RT6451
A	192mm	185mm	225mm	225mm
Side Eared	RS4351E	RS5351E	RS5451E	RS6451E
Side Plain	RS4351	RS5351	RS5451	RS6451
A	250mm	277mm	277mm	300mm
Anti-Splash Eared	RT4352E	RT5352E	RT5452E	RT6452E
Anti-Splash Plain	RT4352	RT5352	RT5452	RT6452
A	225mm	252mm	252mm	275mm
Holderbat				
Description	100mm x 75mm (4" x 3")	125mm x 70mm (5" x 2.75")	125mm x 100mm (5" x 4")	150mm x 100mm (6" x 4")
Build-in (to fit Socket)	RT4360	RT5360	RT5460	RT6460
A	116mm	116mm	116mm	116mm
B	145mm	171mm	171mm	196mm
Ears				
Description	100mm x 75mm (4" x 3")	125mm x 70mm (5" x 2.75")	125mm x 100mm (5" x 4")	150mm x 100mm (6" x 4")
Extra for Fitting Ears to Any Item	RT4365E	RT5365E	RT5465E	RT6465E
Earbands				
Description	100mm x 75mm (4" x 3")	125mm x 70mm (5" x 2.75")	125mm x 100mm (5" x 4")	150mm x 100mm (6" x 4")
Plain	RT4365	RT5365	RT5465	RT6465
Ornamental Please See Below for Available Styles	RT4365O	RT5365O	RT5465O	RT6465O

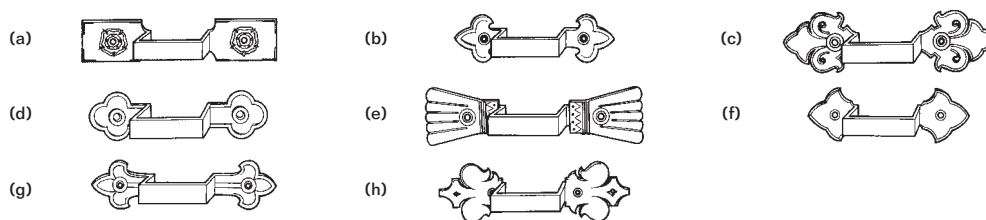

Other styles available to special order.

Please note earbands are manufactured to fit pipe socket.
Any additional information regarding specific sizes can be supplied upon request.



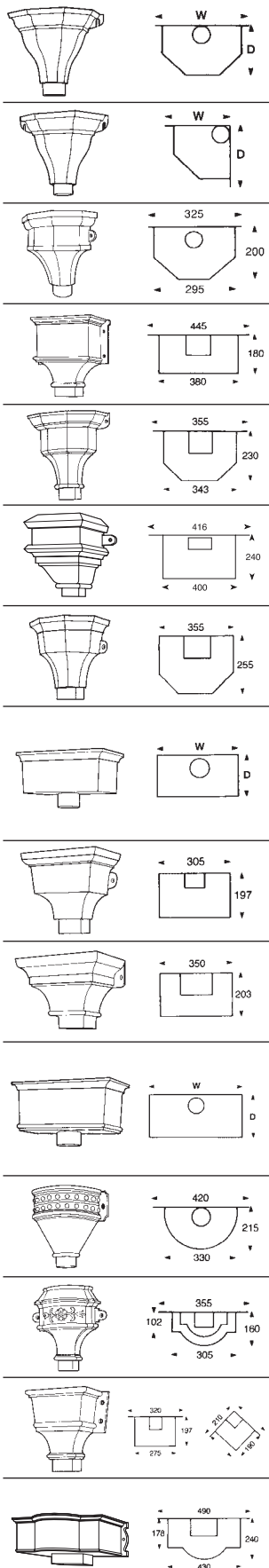

Ornamental Heads		
Description	Width x Depth x Height	
H1 65mm (2.5") Flat Back	305mm x 197mm x 210mm	RH12.5
H1 75mm (3") Flat Back	305mm x 197mm x 210mm	RH13
H1 100mm (4") Flat Back	335mm x 230mm x 240mm	RH14
H1A 65mm (2.5") Corner	210mm x 210mm x 222mm	RH1A2.5
H1A 75mm (3") Corner	210mm x 210mm x 222mm	RH1A3
H1A 100mm (4") Corner	240mm x 240mm x 240mm	RH1A4
H2	325mm x 200mm x 290mm	RH2
H11	445mm x 180mm x 370mm	RH11
H12	355mm x 230mm x 305mm	RH12
H37	416mm x 240mm x 460mm	RH37
H40	355mm x 255mm x 305mm	RH40
H42 305mm (12")	305mm x 184mm x 150mm	RH4212
H42 355mm (14")	355mm x 184mm x 150mm	RH4214
H42 457mm (18")	457mm x 184mm x 150mm	RH4218
H42 610mm (24")	610mm x 184mm x 150mm	RH4224
H55	305mm x 197mm x 255mm	RH55
H58	350mm x 203mm x 203mm	RH58
H82 355mm (14")	355mm x 235mm x 200mm	RH8214
H82 482mm (19")	482mm x 235mm x 200mm	RH8219
H82 610mm (24")	610mm x 235mm x 200mm	RH8224
H82 762mm (30")	762mm x 235mm x 200mm	RH8230
H86	420mm x 215mm x 305mm	RH86
H91	355mm x 160mm x 343mm	RH91
H97 Flat Back	320mm x 197mm x 292mm	RH97
H97A Corner	210mm x 210mm x 292mm	RH97A
H100	490mm x 240mm x 210mm	RH100

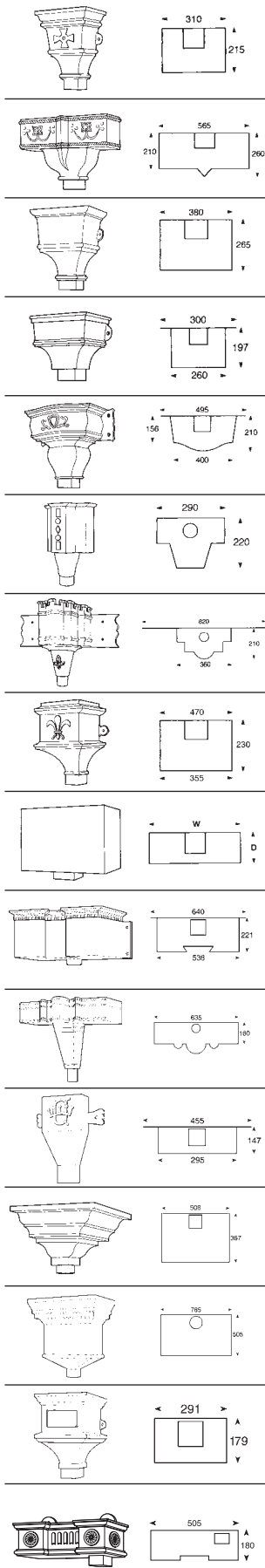

Ornamental Heads		
Description	Width x Depth x Height	
H108	310mm x 215mm x 335mm	RH108
H126	565mm x 260mm x 335mm	RH126
H132	380mm x 265mm x 345mm	RH132
H169	300mm x 197mm x 222mm	RH169
H178	495mm x 210mm x 375mm	RH178
H498	290mm x 220mm x 370mm	RH498
H499	820mm x 210mm x 370mm	RH499
H500	470mm x 230mm x 640mm	RH500
H501	200mm x 150mm x 370mm	RH501
H501L Long	450mm x 150mm x 370mm	RH501L
H510	640mm x 221mm x 243mm	RH510
H511	635mm x 160mm x 510mm	RH511
H512	455mm x 147mm x 471mm	RH512
H513	508mm x 367mm x 340mm	RH513
H514	785mm x 505mm x 582mm	RH514
H515	291mm x 179mm x 429mm	RH515
H516	505mm x 180mm x 167mm	RH516

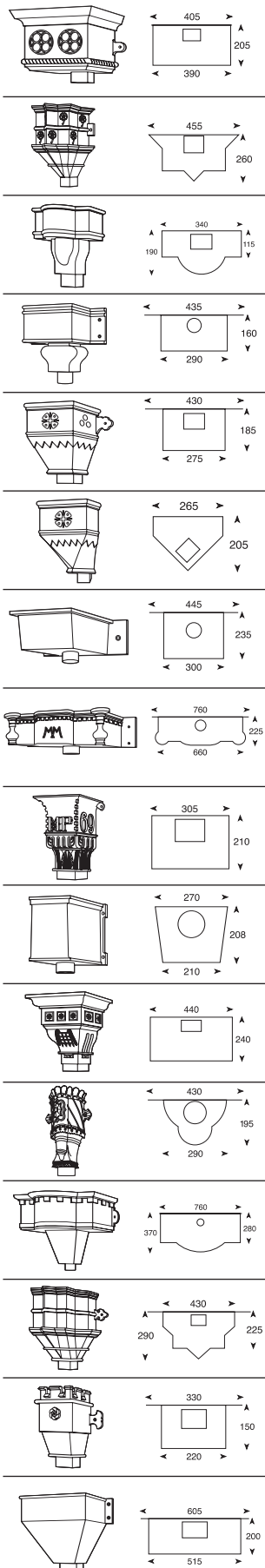

Ornamental Heads		
Description	Width x Depth x Height	
H517	405mm x 205mm x 280mm	RH517
H518	455mm x 260mm x 530mm	RH518
H519	340mm x 190mm x 325mm	RH519
H520	435mm x 160mm x 360mm	RH520
H521 Flat Back	430mm x 185mm x 370mm	RH521
H521A Corner	265mm x 205mm x 360mm	RH521A
H522	445mm x 235mm x 168mm	RH522
H523	760mm x 225mm x 210mm	RH523
H524	305mm x 210mm x 445mm	RH524
H525	270mm x 208mm x 285mm	RH525
H526	440mm x 240mm x 460mm	RH526
H527	430mm x 195mm x 540mm	RH527
H528	760mm x 370mm x 565mm	RH528
H529	430mm x 290mm x 540mm	RH529
H530	330mm x 150mm x 350mm	RH530
H531	605mm x 200mm x 505mm	RH531

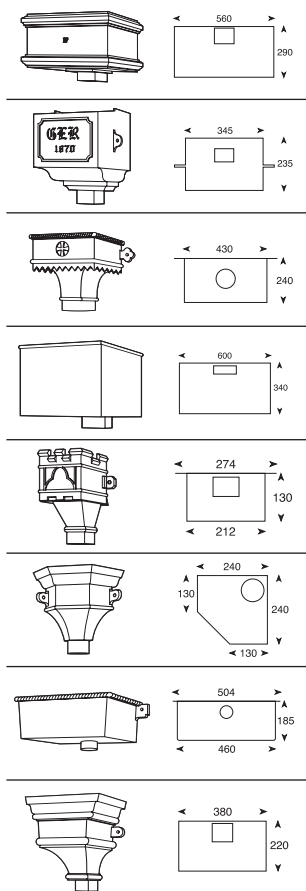

Ornamental Heads		
Description	Width x Depth x Height	
H532	560mm x 290mm x 305mm	RH532
H533	345mm x 235mm x 390mm	RH533
H534	430mm x 240mm x 366mm	RH534
H540	600mm x 340mm x 475mm	RH540
H541	274mm x 130mm x 330mm	RH541
H542A Corner	240mm x 240mm x 290mm	RH542A
H543	504mm x 185mm x 200mm	RH543
H544	380mm x 220mm x 418mm	RH544

Embellishments, (Rose, Date etc.) are available on request.

Please specify size and type of outlet required; Round/ Square/ Rectangular.

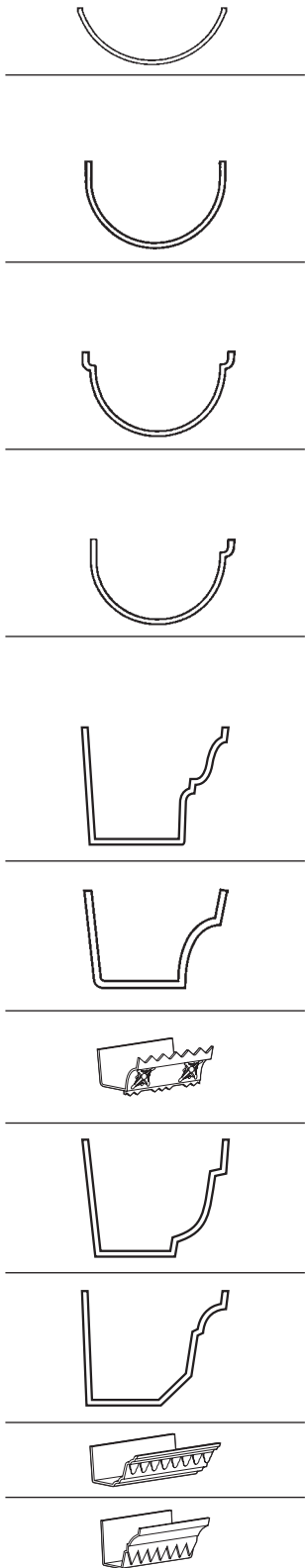

Plain Half Round					
Description	1829mm (6') Gutter	Angle	Nozzle	Stopend	Union Clip
H1 75mm (3")	H13001	H13010	H13020	H13030	H13035
Plain Deep Half Round					
Description	1829mm (6') Gutter	Angle	Nozzle	Stopend	Union Clip
H3 125mm x 100mm	(5" x 4")H35401	H35410	H35420	H35430	H35435
H3 150mm x 100mm	(6" x 4")H36401	H36410	H36420	H36430	H36435
H3 200mm x 100mm	(8" x 4")H38401	H38410	H38420	H38430	H38435
Double Beaded Deep Half Round					
Description	1829mm (6') Gutter	Angle	Nozzle	Stopend	Union Clip
H3A 125mm x 100mm	(5" x 4")H3A5401	H3A5410	H3A5420	H3A5430	H3A5435
H3A 150mm x 100mm	(6" x 4")H3A6401	H3A6410	H3A6420	H3A6430	H3A6435
H3A200mm x 100mm	(8" x 4")H3A8401	H3A8410	H3A8420	H3A8430	H3A8435
Single Beaded Deep Half Round					
Description	1829mm (6') Gutter	Angle	Nozzle	Stopend	Union Clip
H3B 125mm x 100mm (5" x 4")	H3B5401	H3B5410	H3B5420	H3B5430	H3B5435
H3B 150mm x 100mm (6" x 4")	H3B6401	H3B6410	H3B6420	H3B6430	H3B6435
H3B 200mm x 100mm (8" x 4")	H3B8401	H3B8410	H3B8420	H3B8430	H3B8435
Moulded					
Description	1829mm (6') Gutter	Angle	Nozzle	Stopend	Union Clip
H10 125mm x 100mm (5" x 4")	H105401	H105410	H105420	H105430	H105435
H10 190mm x 114mm (7.5" x 4.5")	H108501R	H108510R	H108520R	H108530R	H108535R
H10 200mm x 150mm (8" x 6")	H108601	H108610	H108620	H108630	H108635
H10 250mm x 180mm (10" x 7")	H1010701	H1010710	H1010720	H1010730	H1010735
H12 125mm x 75mm (5" x 3")	H125301	H125310	H125320	H125330	H125335
H12 125mm x 100mm (5" x 4")	H125401	H125410	H125420	H125430	H125435
H12 150mm x 100mm (6" x 4")	H126401	H126410	H126420	H126430	H126435
H12 200mm x 114mm (8" x 4.5")	H128501R	H128510R	H128520R	H128530R	H128535R
H12S 133mm x 100mm (5.25" x 4")	H12S5401R	H12S5410R	H12S5420R	H12S5430R	H12S5435R
H13 125mm x 100mm (5" x 4")	H135401	H135410	H135420	H135430	H135435
H14 125mm x 115mm (5" x 4.5")	H145501R	H145510R	H145520R	H145530R	H145535R
H14 150mm x 100mm (6" x 4")	H146401	H146410	H146420	H146430	H146435
H14 150mm x 115mm (6" x 4.5")	H146501R	H146510R	H146520R	H146530R	H146535R
H14S 150mm x 100mm (6" x 4")	H14S6401	H14S6410	H14S6420	H14S6430	H14S6435
H14S 150mm x 150mm (6" x 6")	H14S6601	H14S6610	H14S6620	H14S6630	H14S6635

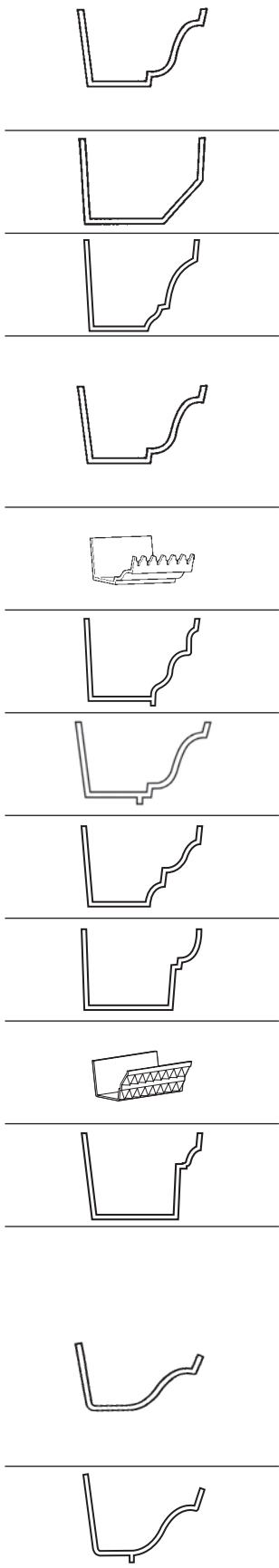

Moulded					
Description	1829mm (6') Gutter	Angle	Nozzle	Stopend	Union Clip
H16 125mm x 100mm (5" x 4")	H165401	H165410	H165420	H165430	H165435
H16 150mm x 100mm (6" x 4")	H166401	H166410	H166420	H166430	H166435
H16 230mm x 115mm (9" x 4.5")	H169501R	H169510R	H169520R	H169530R	H169535R
H16 292mm x 127mm (11.5" x 5")	H1612501R	H1612510R	H1612520R	H1612530R	H1612535R
H16 340mm x 115mm (13.5" x 4.5")	H1614501R	H1614510R	H1614520R	H1614530R	H1614535R
H38 150mm x 125mm (6" x 5")	H386501	H386510	H386520	H386530	H386535
H38 157mm x 180mm (6.25" x 7")	H386701R	H386710R	H386720R	H386730R	H386735R
H38 292mm x 125mm (11.5" x 5")	H3812501R	H3812510R	H3812520R	H3812530R	H3812535R
H44 180mm x 125mm (7" x 5")	H447501	H447510	H447520	H447530	H447535
H44 215mm x 150mm (8.5" x 6")	H448601R	H448610R	H448620R	H448630R	H448635R
H44 230mm x 157mm (9" x 6.25")	H449601R	H449610R	H449620R	H449630R	H449635R
H46 150mm x 115mm (6" x 4.5")	H466501R	H466510R	H466520R	H466530R	H466535R
H46 150mm x 125mm (6" x 5")	H466501	H466510	H466520	H466530	H466535
H46 180mm x 125mm (7" x 5")	H467501	H467510	H467520	H467530	H467535
H46 190mm x 125mm (7.5" x 5")	H468501R	H468510R	H468520R	H468530R	H468535R
H46 215mm x 157mm (8.5" x 6.25")	H469601R	H469610R	H469620R	H469630R	H469635R
H46S 100mm x 75mm (4" x 3")	H46S4301	H46S4310	H46S4320	H46S4330	H46S4335
H46D 180mm x 155mm (7" x 6")	H46D7601	H46D7610	H46D7620	H46D7630	H46D7635
H46D 200mm x 115mm (8" x 4.5")	H46D8501R	H46D8510R	H46D8520R	H46D8530R	H46D8535R
H48 230mm x 150mm (9" x 6")	H489601	H489610	H489620	H489630	H489635
H77 185mm x 125mm (7.25" x 5")	H777501R	H777510R	H777520R	H777530R	H777535R
H77 200mm x 133mm (8" x 5.25")	H778501R	H778510R	H778520R	H778530R	H778535R
H101 140mm x 120mm (5.5" x 4.75")	H1016501R	H1016510R	H1016520R	H1016530R	H1016535R
H102 180mm x 125mm (7" x 5")	H1027501	H1027510	H1027520	H1027530	H1027535
Deep OG					
Description	1829mm (6') Gutter	Angle	Nozzle	Stopend	Union Clip
H23 125mm x 75mm (5" x 3")	H235301	H235310	H235320	H235330	H235335
H23 125mm x 100mm (5" x 4")	H235401	H235410	H235420	H235430	H235435
H23 150mm x 100mm (6" x 4")	H236401	H236410	H236420	H236430	H236435
H23 157mm x 133mm (6.25" x 5.25")	H236501R	H236510R	H236520R	H236530R	H236535R
H23 180mm x 125mm (7" x 5")	H237501	H237510	H237520	H237530	H237535
H23D 190mm x 125mm (7.5" x 5")	H23D8501R	H23D8510R	H23D8520R	H23D8530R	H23D8535R
H23D 200mm x 125mm (8" x 5")	H23D8501	H23D8510	H23D8520	H23D8530	H23D8540

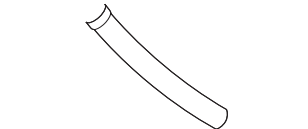
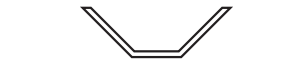
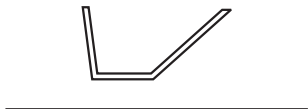
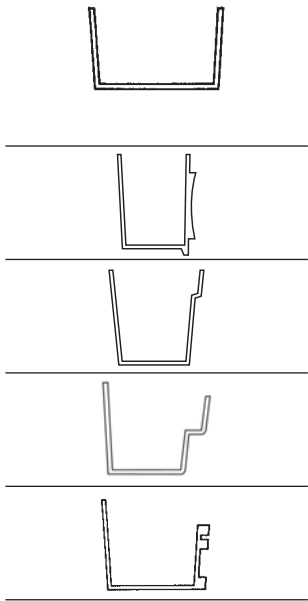

Socket & Spigot Box					
Description	1829mm (6') Gutter	Angle	Nozzle	Stopend	Union Clip
H25 100mm x 100mm (4" x 4")	H254401	H254410	H254420	H254430	H254435
H25 125mm x 100mm (5" x 4")	H255401	H255410	H255420	H255430	H255435
H25 150mm x 75mm (6" x 3")	H256301	H256310	H256320	H256330	H256335
H25 150mm x 100mm (6" x 4")	H256401	H256410	H256420	H256430	H256435
H25 150mm x 150mm (6" x 6")	H256601	H256610	H256620	H256630	H256635
H25 200mm x 200mm (8" x 8")	H258801	H258810	H258820	H258830	H258835
H25S 115mm x 150mm (4.5" x 6")	H25S5601R	H25S5610R	H25S5620R	H25S5630R	H25S5635R
H25S 150mm x 150mm (6" x 6")	H25S6601	H25S6610	H25S6620	H25S6630	H25S6635
H25S 200mm x 180mm (8" x 7")	H25S8701	H25S8710	H25S8720	H25S8730	H25S8735
H25S 160mm x 130mm x 115mm (6" x 4" x 4.5") with Ornamental Front	H25S6401	H25S6410	H25S6420	H25S6430	H25S6435
Boundary Wall					
Description	1829mm (6') Gutter	Angle	Nozzle	Stopend	Union Clip
H28 190mm x 150mm (7.5" x 6") with 140mm Sole	H288601R	H288610R	H288620R	H288630R	H288635R
H28 305mm x 125mm (12" x 5") with 200mm Sole	H2812501	H2812510	H2812520	H2812530	H2812535
Valley					
Description	1829mm (6') Gutter	Angle	Nozzle	Stopend	Union Clip
H35 380mm x 125mm (15" x 5") with 125mm Sole	H3515501	H3515510	H3515520	H3515530	H3515535
Radius (Curved)					
Description	1000mm (3' 3") Gutter	Angle	Nozzle	Stopend	Union Clip
Various Patterns & Profiles Available to Suit Specified Radius	RAD01				

